



BTSCOVER
MECHANICAL PROTECTION SYSTEMS

www.btscover.com

HAKKIMIZDA

Konusunda uzmanlaşmış kadromuz ile vizyon hedefinize ulaşmanıza engel olabilecek sorunları ortadan kaldırmak, sektörel rekabeti arttırarak yüksek kalitede üretim ile kalitesizlik maliyetini minimum seviyeye düşüren, müşteri odaklı bir hedefle BTS COVER hizmetinize sunulmuştur.

Kısa bir zaman içinde tercih edilen bir firma konumuna ulaşip alınan bu yolda sürekli gelişerek rekabet gücümüzü arttırıyoruz.

- Proje çalışmalarınıza destek vermek amacı ile tasarım birimimizi faaliyete geçirdik.
- Koruma sistemleri dışında mekanik ürün seçimi ve tedarik ağımla destek gücümüzü arttırdık.

Hedefimiz, yurt içinde ve yurt dışında partner olarak çalıştığımız firmaları hedefledikleri vizyona ulaştırmak ve bu alanda sorumluluk sahibi hizmetler vermektir.

Geniş servis ve yedek parça ağımla ile 10 yılı aşkın süredir hizmet verdiğimiz sektörde, yaklaşık 1000m2 çalışma alanı ve 25 personel ile müşterilerimiz için profesyonel çözümler sağlamaktayız.

İÇERİK / İNDEX

Teleskopik Sac Muhafazalar
Telescopic Steel Covers

03

Özel Tasarımlar
Special Products

08

ATC Kapağı / ATC Kapısı
ATC Door

09

Klasik Bez Körük
Classic Fabric Bellows

10

Lazer Işın Yolu Körükleri
Laser Beam Way Bellows

13

Saclı Bez Körük
Fabric Bellows With Steel

14

Silindir Bez Körük
Cylindrical Fabric Bellows

16

Rulo Muhafaza
Roller Covers

18

Alüminyum Perde
Aluminum Covers

21

Platform Körükleri
Platform Bellows

23

Spiral Yay Muhafazalar
Spiral Spring Cover

25

Teleskobik Koruma Materyalleri
Components For Telescopic Steel Cover

31

Yedek Parçalar
Replacement Parts

32

Teleskobik Sac Muhafazalar

BTS Cover Teleskobik Sac Muhafazaları, makina tezgahlarına ait kızakları, vidalı milleri korumak ve çeşitli çalışma alanlarında mekanik korumanın yanı sıra iş güvenliğini etkileyen problemleri ortadan kaldıran, özel tasarım ve proje destekli üretilen çözüm anahtarlarımızdan biridir.

BTS Cover Mekanik Koruma Sistemleri tarafından tasarlanan çözüm anahtarları, yüksek sertlik derecesine sahip ithal saclar kullanılarak, yüksek büküm hassasiyetiyle üretilirler.

Verimli çalışma sağlayarak mekanik bakım maliyetini minimum seviyede tutan ürünlerimizi sürekli geliştiriyor, AR-GE ve ÜR-GE çalışmalarımıza yapılan yatırımlarımız ile rekabet gücümüzü sürekli artırıyoruz.

Teleskobik Sac Muhafazalar

Telescopic Steel Covers

Çalışma Pozisyonları / Working Positions

Yatay Pozisyon

Genellikle (X) eksen uygulamalarında kullanılır.
Farklı ebatlarda üretilebilir.

Horizontal Pozition

Generally used for (X) axis applications.
Can be produced in various sizes.

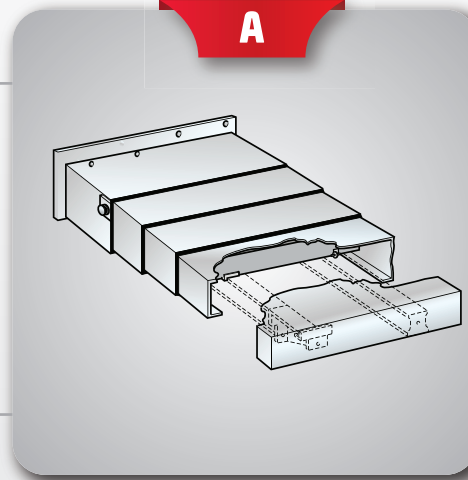

B

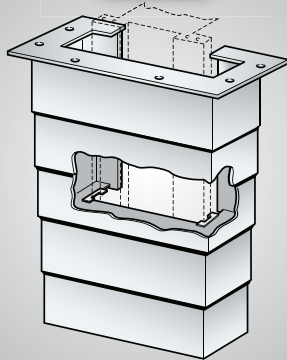

Dikey Pozisyon

Genellikle (Z) eksen uygulamalarında kullanılır.
Farklı ebatlarda üretilebilir.

Vertical Pozition

Generally used for (Z) axis applications.
Can be produced in various sizes.

Enine Pozisyon

Genellikle (Y) eksen uygulamalarında kullanılır.
Farklı ebatlarda üretilebilir.

Transverse Pozition

Generally used for (Y) axis applications.
Can be produced in various sizes.

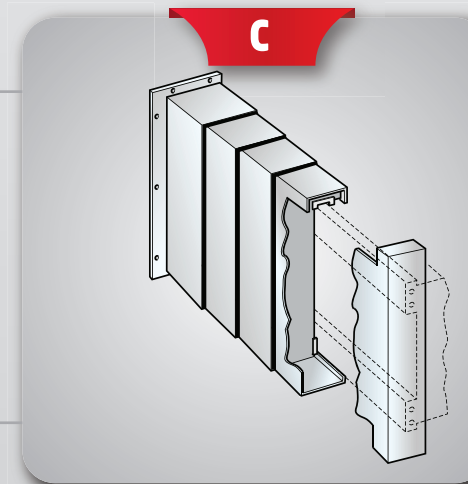

Teleskobik Koruma Materyalleri

Components Fot Telescopic Steel Cover

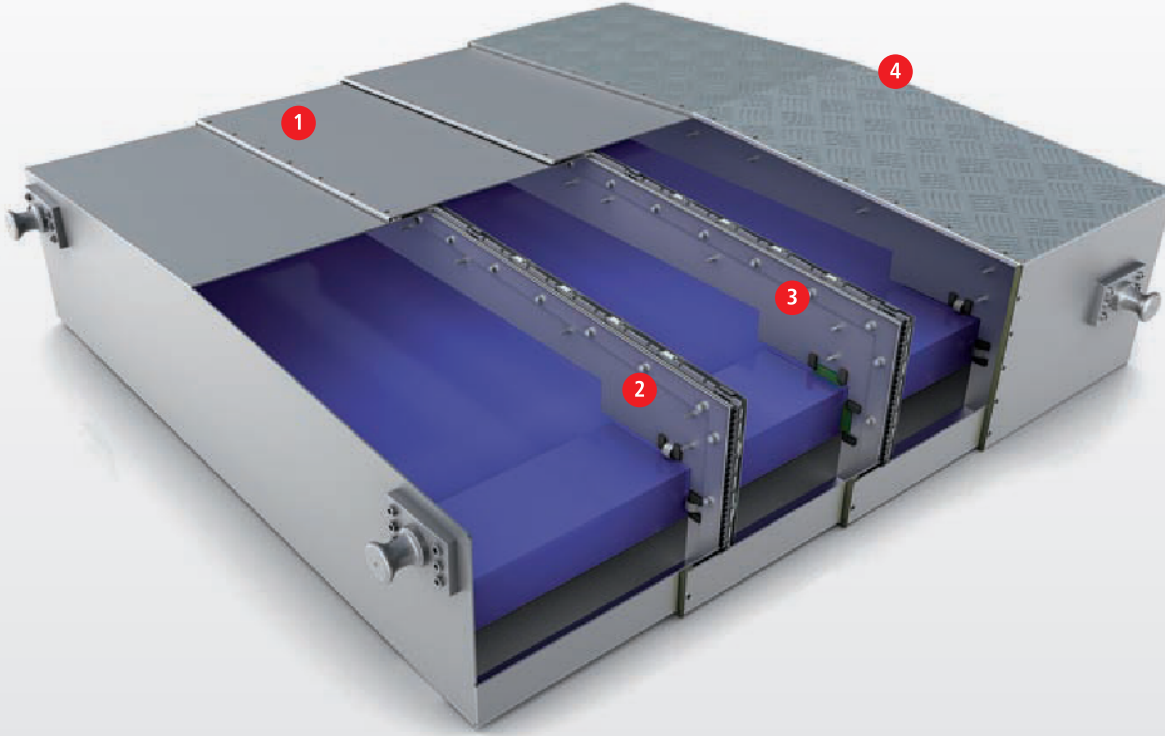

Kızak Sıyırıcı

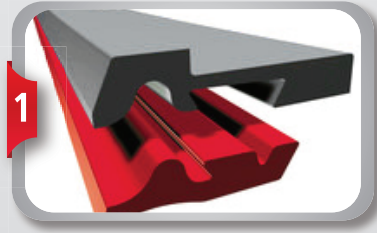

(Sayfa :12/15)

Taşıyıcı Rulman



Kızak Kaydırıcı

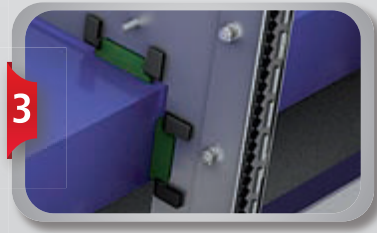

Personel Taşıyıcı Sac



Teleskobik Koruma Materyalleri

Components Fot Telescopic Steel Cover

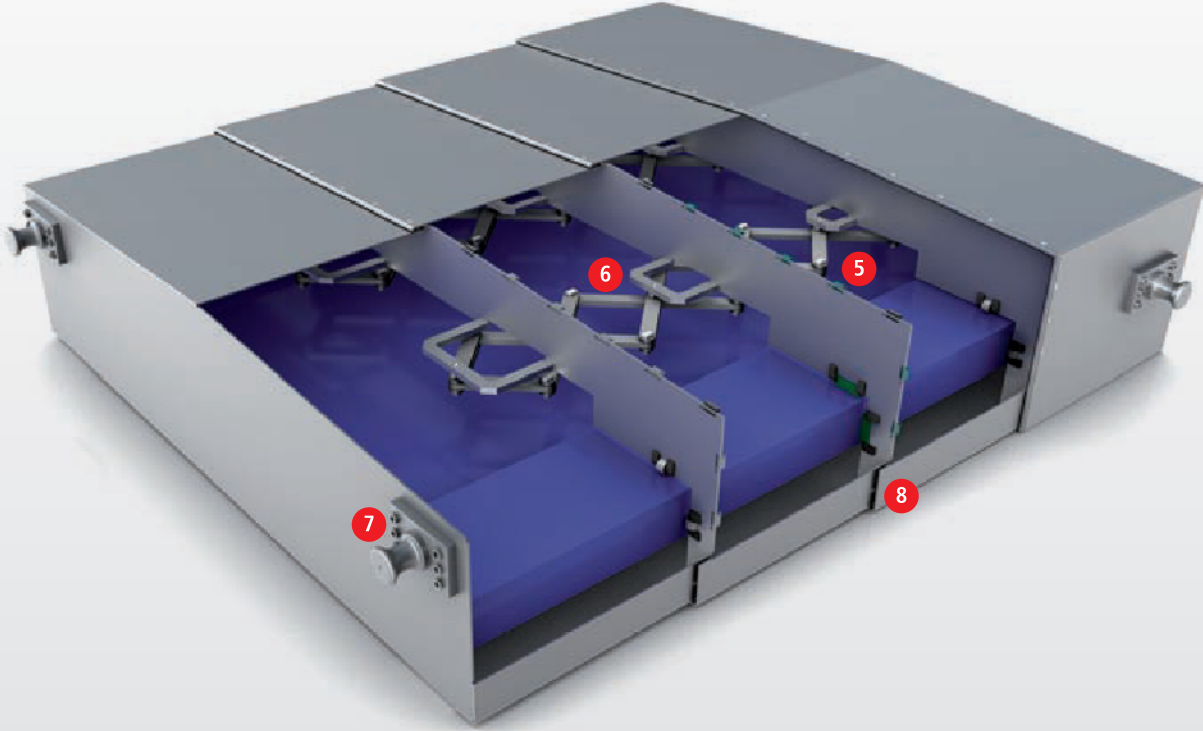

Darbe Sönümleyici

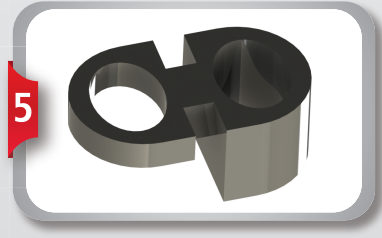

Makas

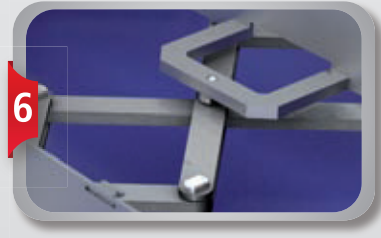

CK-75

Ürün Taşıma Burc'u



Pirinc Destekleyiciler

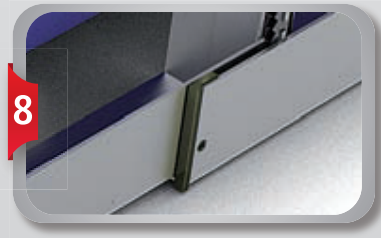



Özel Tasarımlar



Special Products

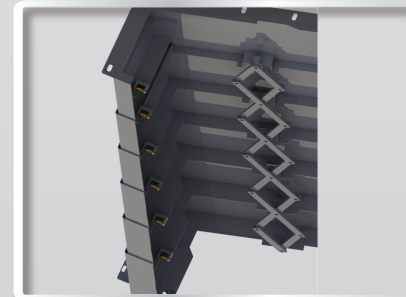
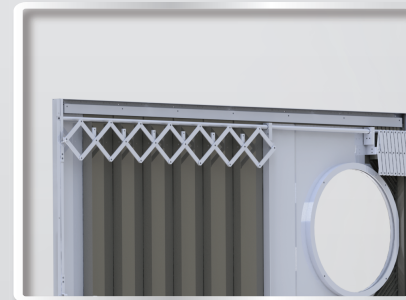
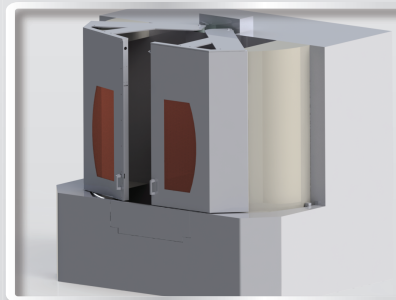
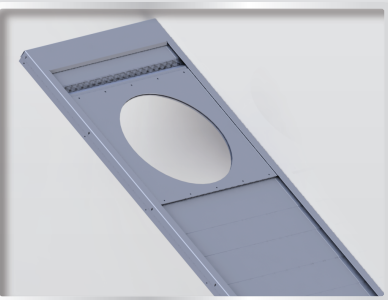
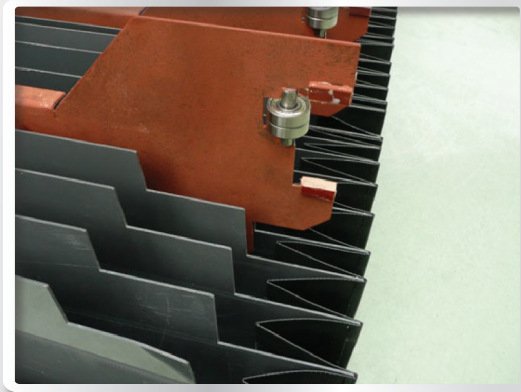
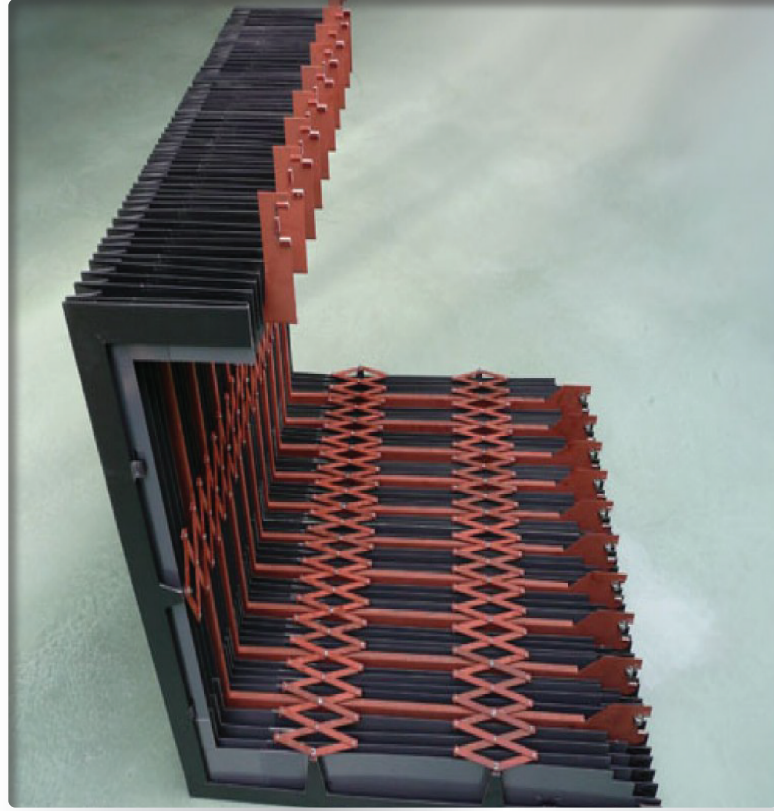



ATC Kapađı - ATC Kapısı



ATC Door

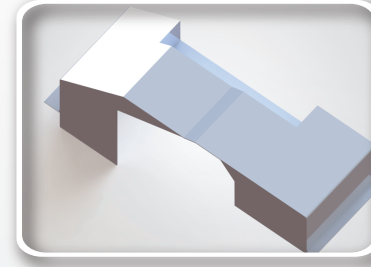
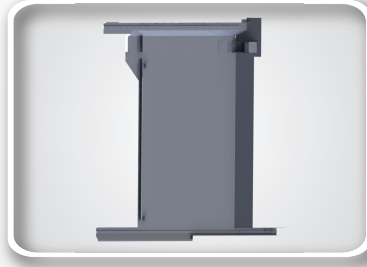
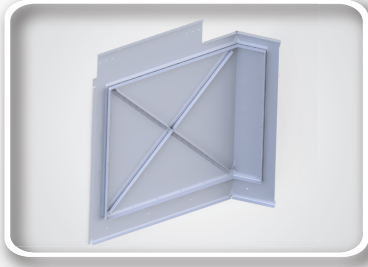

Sıklıkla karşılaştığımız problemlerden biri olan ATC Kapıları/Kapakları, çok daha verimli çalışmasını sağlayan malzeme seçimimizle ve tasarımlarımızla oluşturduğumuz çözüm anahtarlarımızdandır.

BTS Cover Mekanik Koruma Sistemleri, deneyimlerini çözüm odaklı kullanmak için geliştirdiđi ürünlerde; hızlı üretimin yanısıra en uygun fiyat garantisi vermektedir.

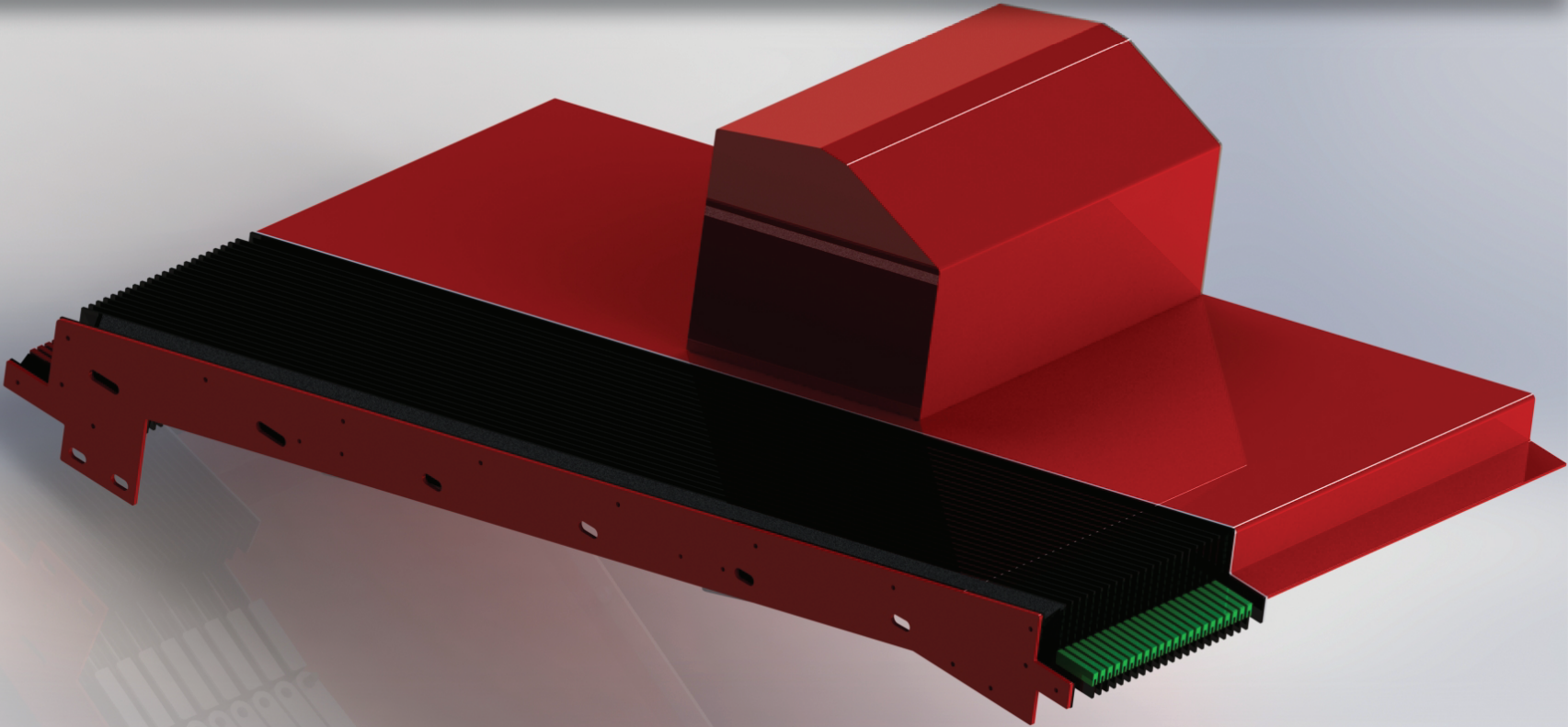

Klasik Bez K r k

Classic Fabric Bellows

BTS Cover Bez K r kleri, makina tezgahlarına ait kızakları, vidalı milleri korumak ve eřitli alıřma alanlarında mekanik korumanın yanısıra iř g venliđini etkileyen problemlilerdeki ihtiyaları ortadan kaldıran  zel tasarım ve proje destekli  retilen  z m anahtarlarımızdandır.

Y ksek muhavemete ve alıřma ortamına ait kořullara bađlı olarak y ksek sıcaklıklara dayanıklı ithal kumařlar kullanılarak  retilen bez k r klerimizde s rt nmeye ve ařınmaya dayanıklı pvc kullanılmaktadır.

BTS Cover Mekanik Koruma Sistemleri ileri  retim teknolojisi ve kullandığı y ksek kaliteli malzemeler ile en yakın muadil  r ne g re ok daha uzun  m rl  koruma sađlar.

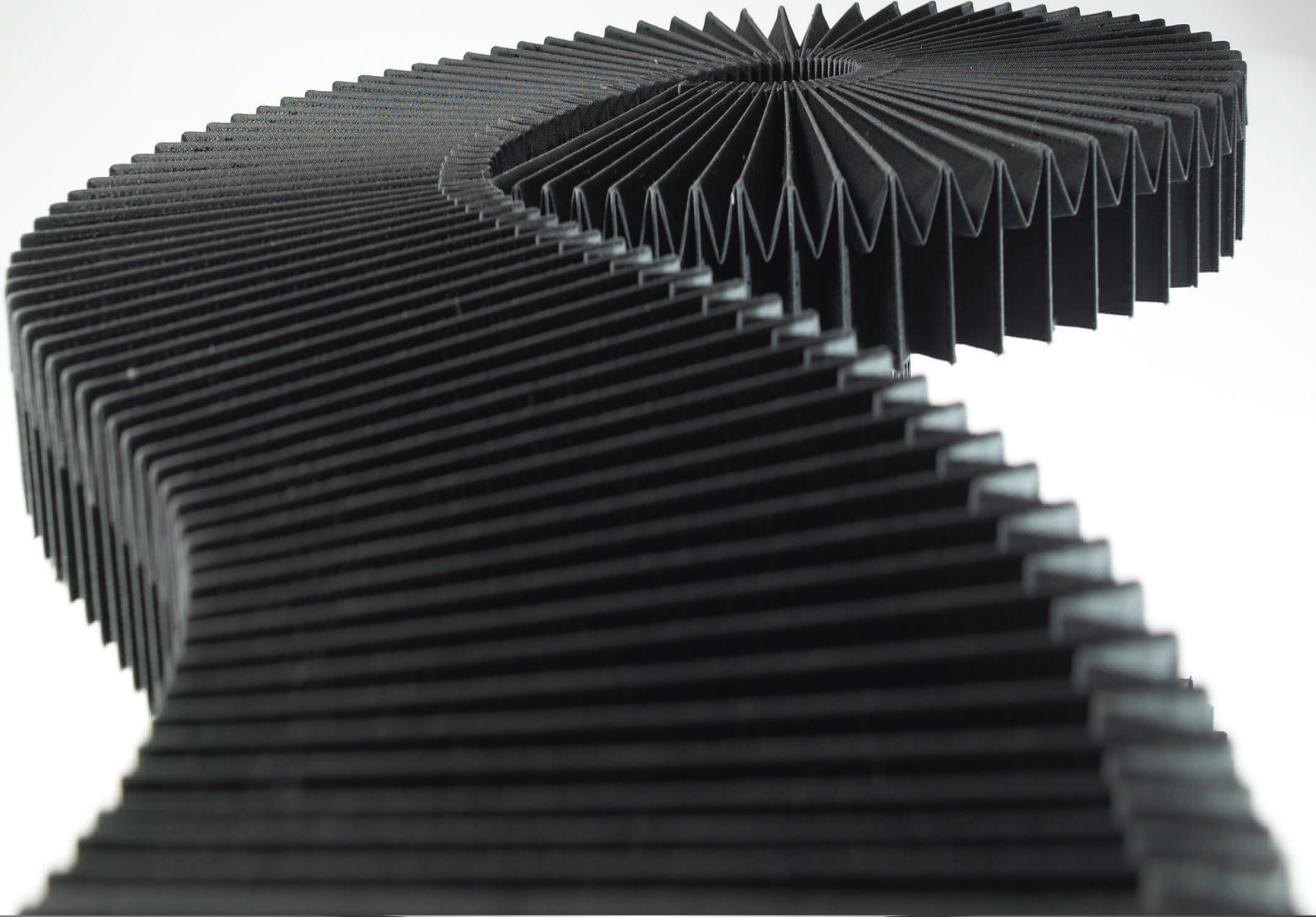

Kumaş Özellikleri

Fabric Properties

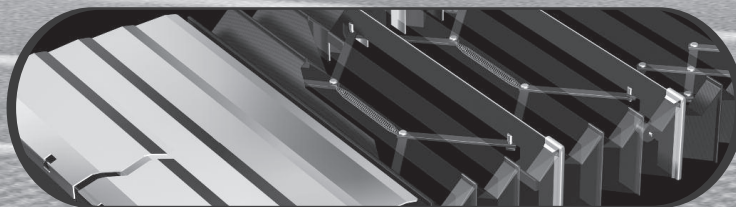
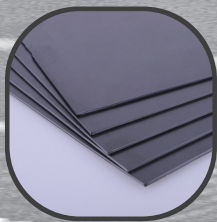

Specification Number	Coating ext.	Coating int.	Carrier	Thickness (mm)	Color	Heat Sealed	Stitched	Lamella	Round Stitched	Resistant to wear	Resistant against oil, greases & coolants	Surface stability	Resistant against swarf, welding splatter forging scales	Self extinguishing	Frame resistant	Ratio between extension and compression
BTS-PUR	PUR	PUR	Polyester	0.35	Black	x	x	x		+	+	++	+	o	-	+
ERA 7810	PUR	PUR	Polyester	0.22	Blk/Gry	x	x			+	o	o	o	o	-	++
PUR-Kevlar	PUR	PUR	Kevlar	0.36	Blk/Gry	x	x	x	x	++	+	++	+	+	+	+
BTS-23	PVC	PVC	Polyester	0.23	Black	x	x			+	-	o	-	-	-	++
BTS-35	PVC	PVC	Polyester	0.36	Black	x	x	x		+	+	+	o	o	-	+
Alum-Aramid	ALU		Nomex	0.35	Silver	x	x		x	+	o	+	++	++	+	+
PUR/Teflon	PTFE	PUR	Polyester	0.30	Black	x	x	x		++	++	++	o	o	-	+
Neoprene	NEP	NEP	Nylon	0.40	Black	x	x	x	x	++	++	++	++	o	-	o
Hypalon	HYP	HYP	Nylon	0.40	Black	x	x	x	x	+	++	+	o	o	-	o

- unsuitable, o suitable, + good, ++ very good

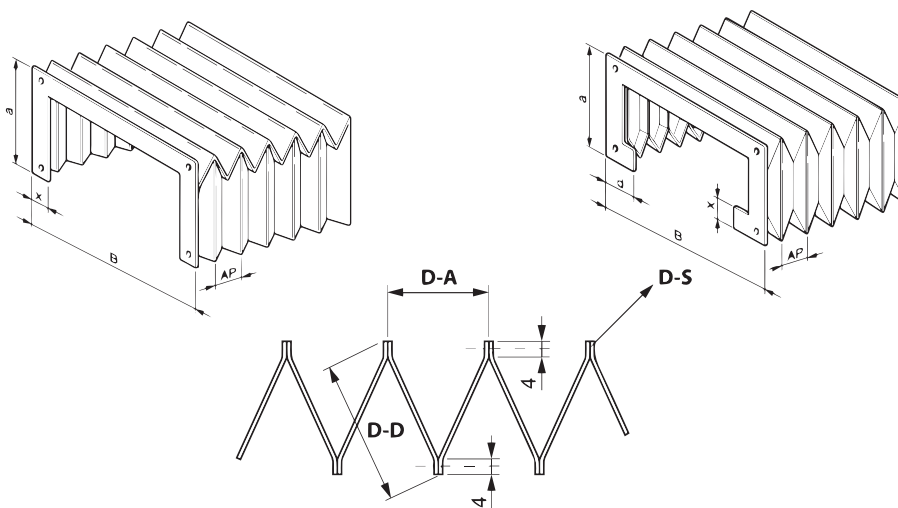
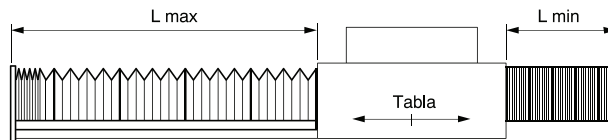

* D S = Dilim Derinliği * D A = Dilim Sayısı * D D = Dilim Derinliği

Standart Bez Körükler

Standart Fabric Bellows

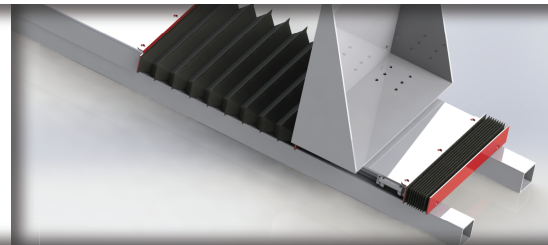
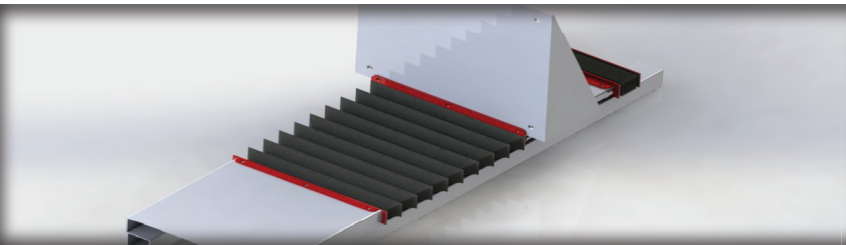
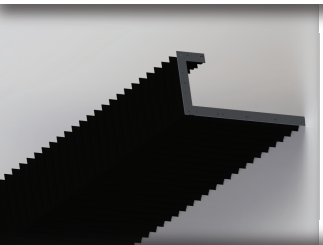
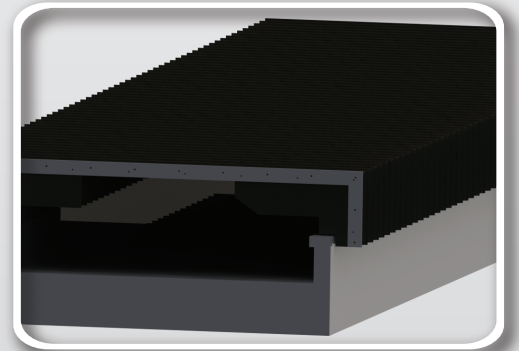
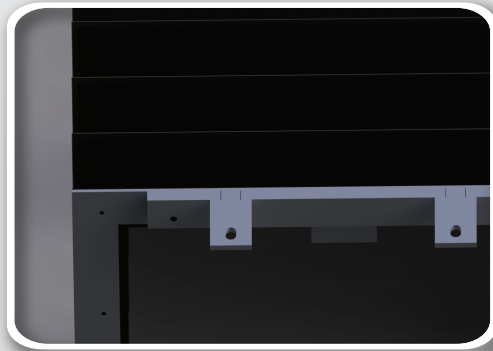
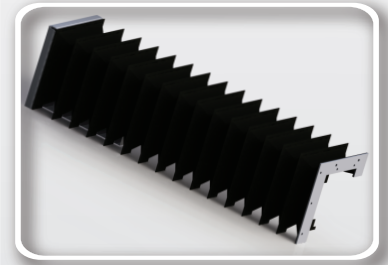
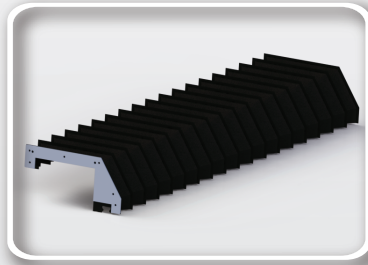
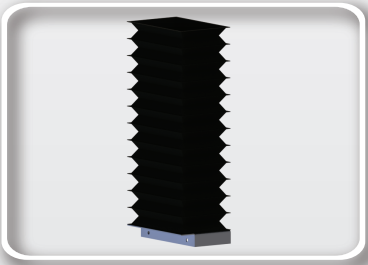
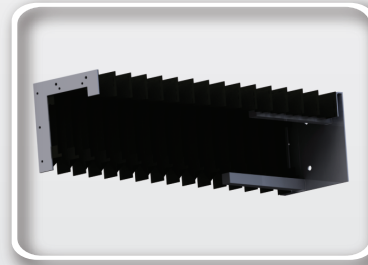
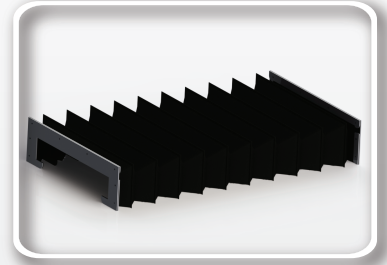
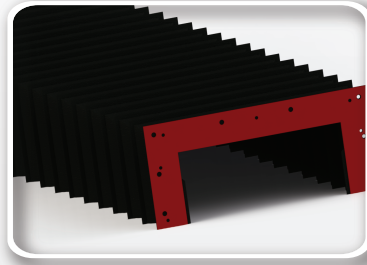
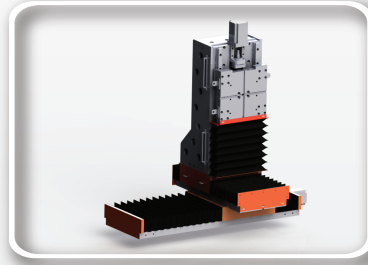
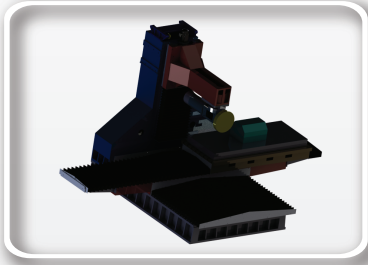



Lazer Işın Yolu Körükleri



Laser Beam Way Bellows

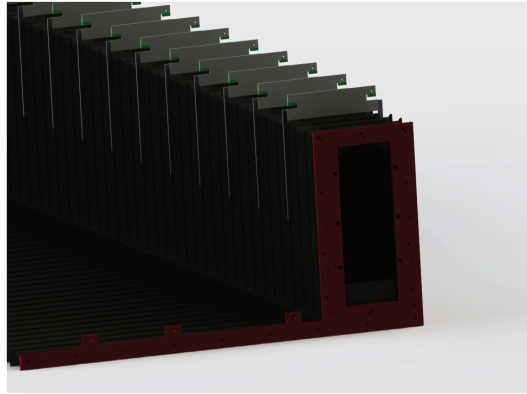
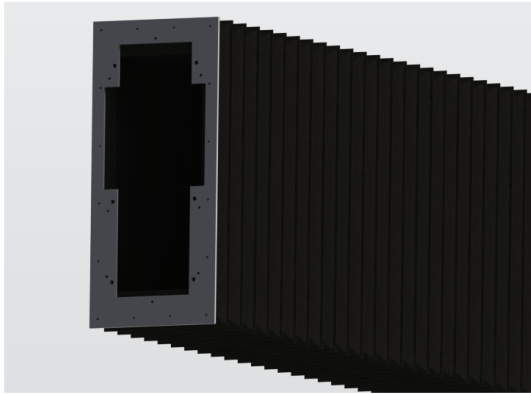
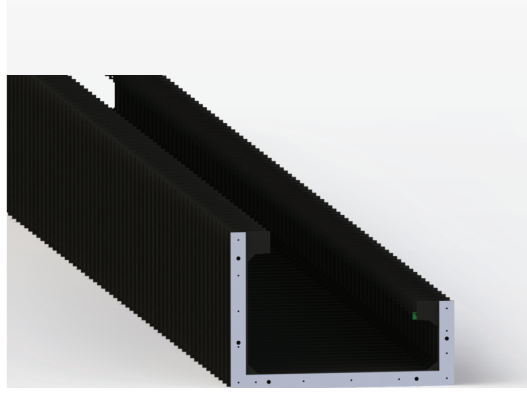
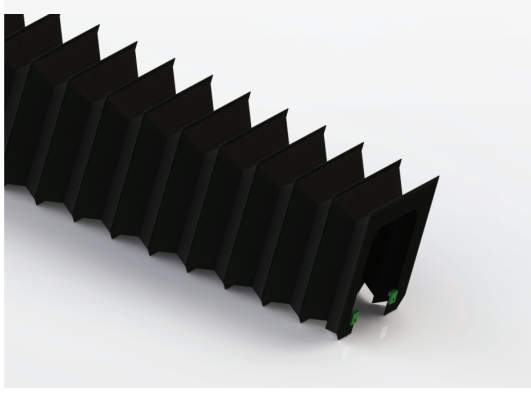

İleri teknolojiye sahip kesim makinalarında ışın yoluna sıvı ve ışık sızdırmazlığı sağlayan BTS Cover Işın Körükleri, yüksek hassasiyete sahip üretimi ile lazer, plazma ve su jeti makinalarında maksimum koruma sağlar. Tüm makina modellerinin çalışma şartlarına göre tasarlanan ve üretilen BTS Cover Işın Körükleri en hızlı teslim süresini ve düşük fiyatı garanti eder.

Saclı Bez K r k

Fabric Bellows With Steel

BTS Cover Saclı Bez K r kleri, y ksek sıcaklıęa sahip kaynak pozisyoneri ve yoęun kaba talaşın bulunduęu b lgelerde bez k r ę  koruma amalı tasarlanan paslanmaz sac akuple edilerek b lgesel korumayı maksimum seviyeye ıkartır.

S rt nmeye karşı y ksek dayanım saęladıęı gibi, alıřma esnasında oluřabilecek sorunları esneklięi sayesinde absorbe eder.

BTS Cover Mekanik Koruma Sistemleri, y ksek mukavemete sahip bez k r klerine ilave edilen yaylı paslanmazlar sayesinde bir  nceki dilime baskı uygular ve bez k r ę n dıř etkenlere maruz kalmasını engeller. Bu sayede, kullanılan alanda koruma katlanarak ok daha uzun  m rl  alıřma saęlar.



Saclı Bez Körük



Fabric Bellows With Lamella

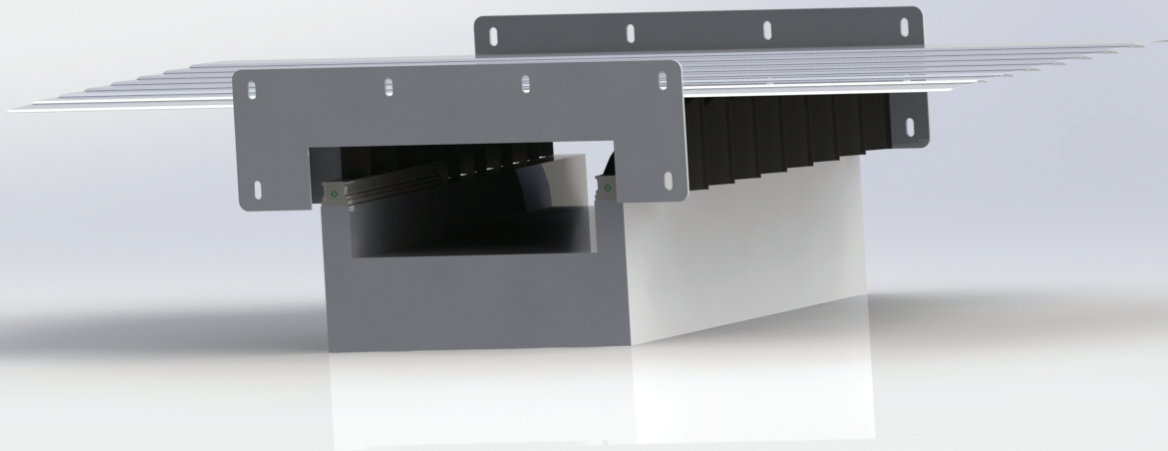
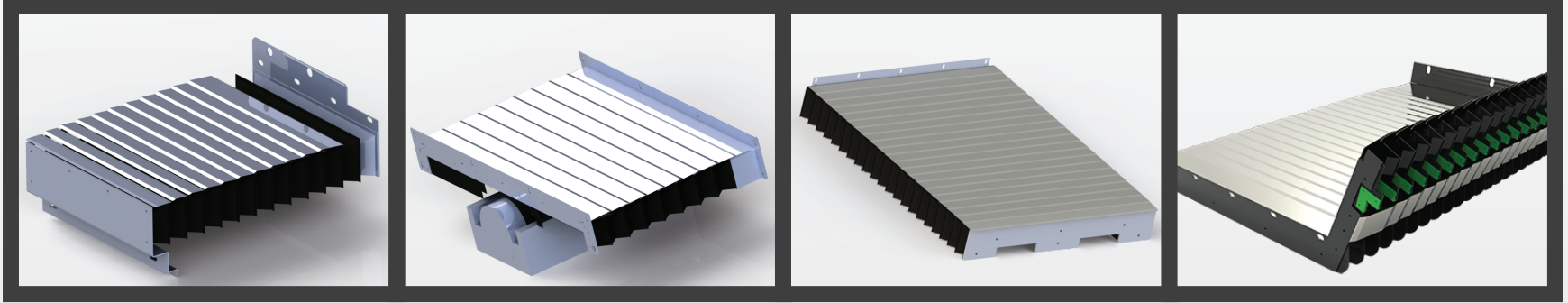

TOURPOSTH

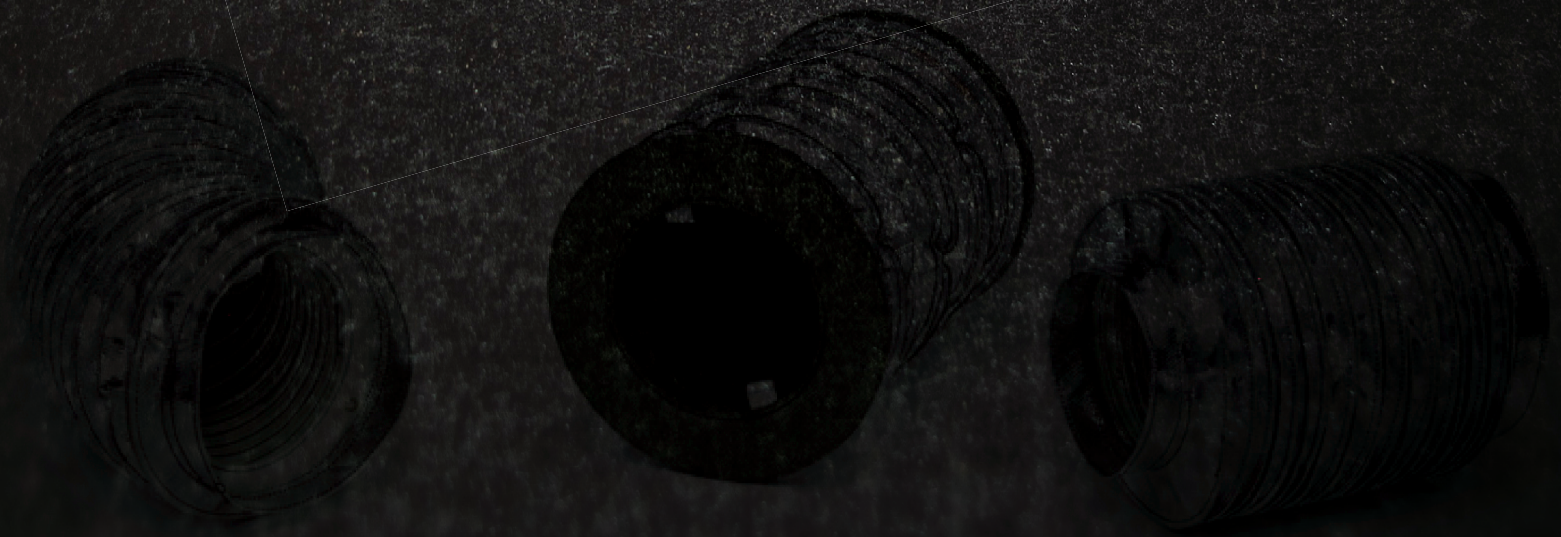
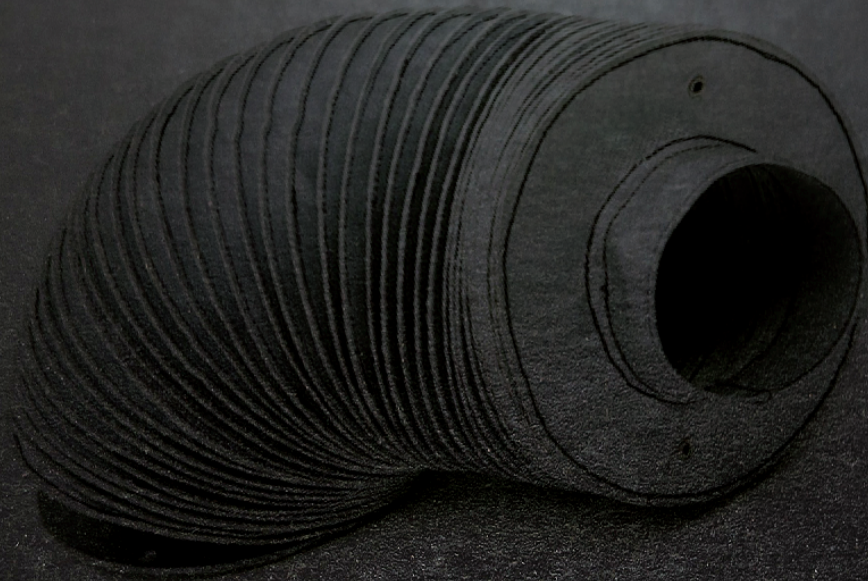

Silindir Bez Körük

Cylindrical Fabric Bellows

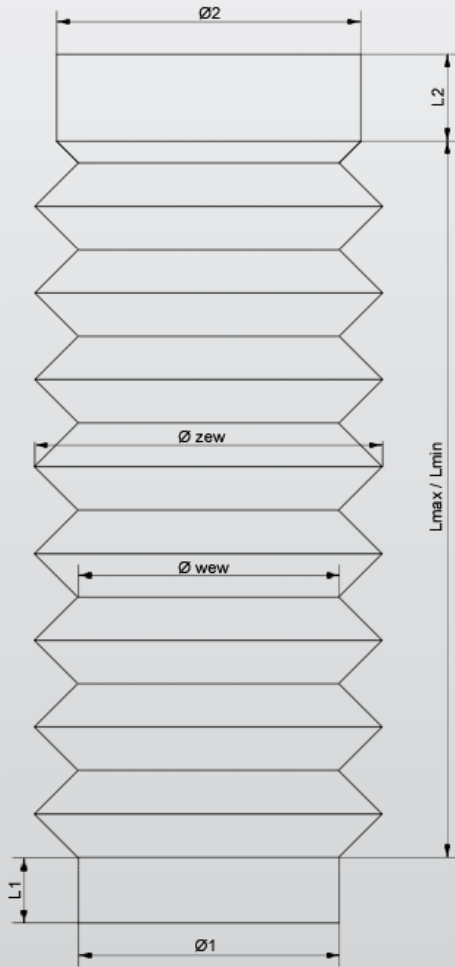
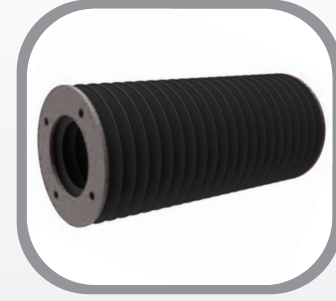
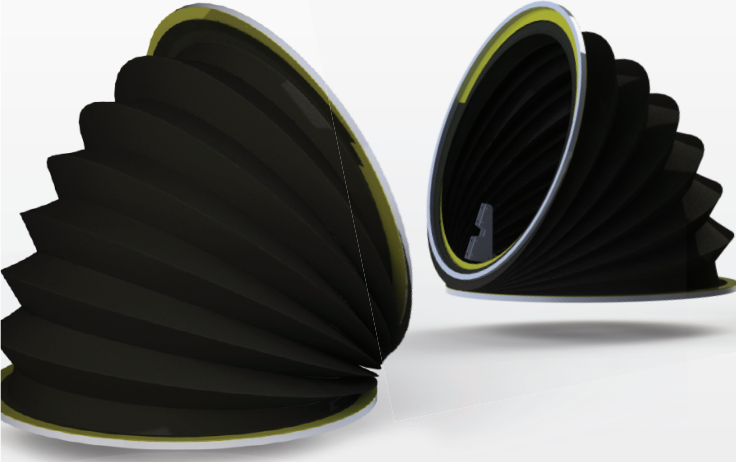

BTS Cover Silindir Körükleri, dairesel alanlarda endüstriyel kumaşların birbirine akuple edilmesiyle üretilir.

Vidalı mil, hidrolik ve pinomatik sistemlerde, dairesel platforma ve çalışma proseslerinde yatay veya dikey konumda yüksek koruma sağlar.

Yüksek sıcaklık gerektiren veya çok yüksek mukavemet gerektiren çalışma koşullarında BTS Cover mekanik koruma sistemleri zengin teknik kumaş çeşitliliğiyle ihtiyaca yönelik çözümler sunar.

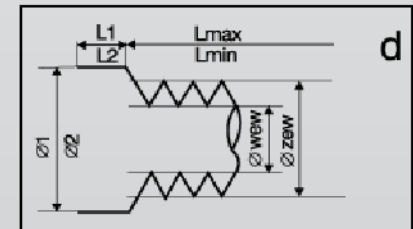
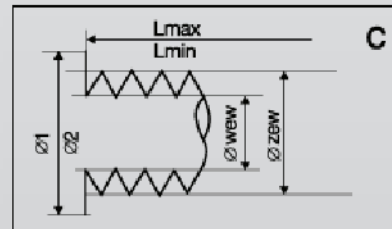
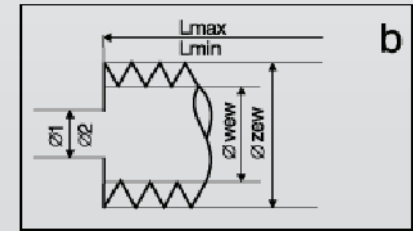
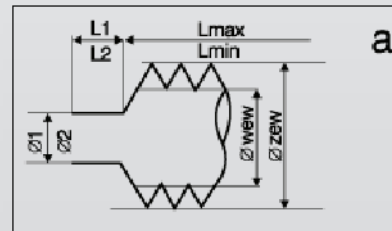



Rulo Muhafaza



Roller Covers

BTS Cover Rulo Muhafaza Sistemleri, makina tezgahlarına ait kızakları, vidalı milleri korumak ve çeşitli çalışma alanlarında mekanik korumanın yanısıra iş güvenliğini etkileyen problemleri ortadan kaldıran özel tasarım ve proje destekli üretilen çözüm anahtarlarımızdır.

Yüksek muhavemete ve çalışma ortamına ait koşullara bağlı olarak yüksek sıcaklıklara dayanıklı ithal kumaşlar kullanılarak üretilmektedir.

BTS Cover Mekanik Koruma Sistemleri ileri üretim teknolojisi ve kullandığı yüksek kaliteli malzemeler ile en yakın muadil ürüne göre çok daha uzun ömürlü koruma sağlar.

Rulo Muhafazalar

Roller Covers

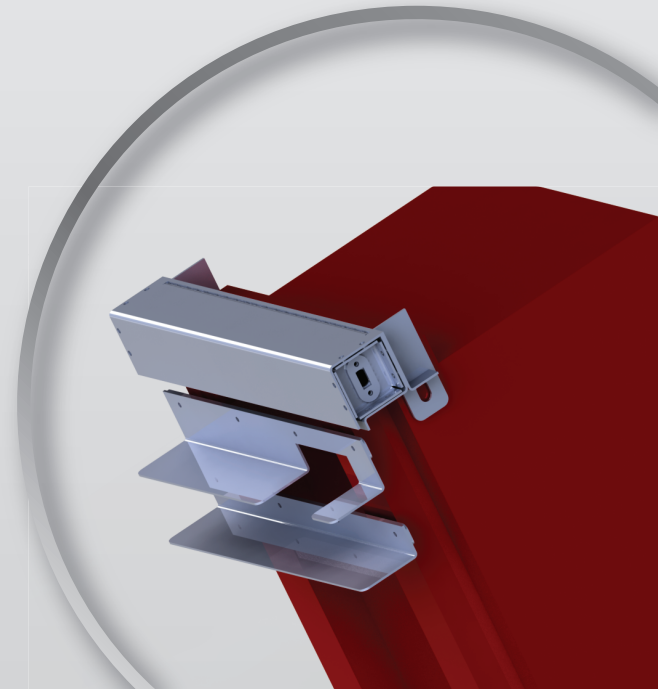
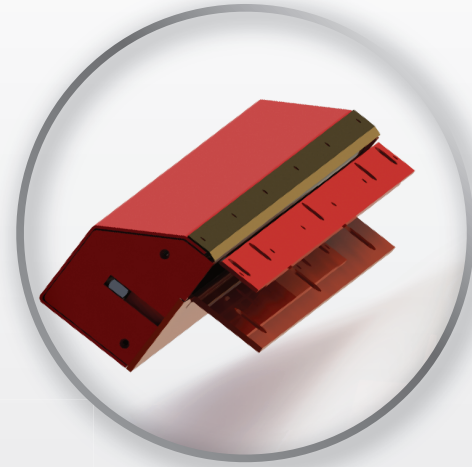
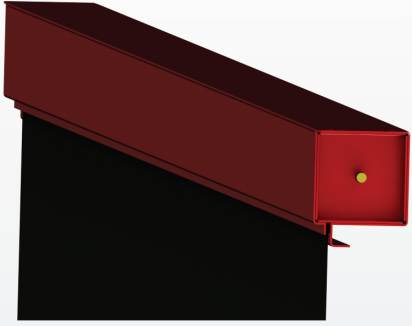

Rulo Muhafazalar

Roller Covers

Teknik Özellikler / Technic Properties

Specification Number	Coating		Carrier	Thickness (mm)	Color	Heat Sealed	Stitched	Lamella	Round Stitched	Resistant to wear	Resistant against oil, greases & coolants	Surface stability	Resistant against swarf, welding splatter forging scales	Self extinguishing	Frame resistant	Ratio between extension and compression
	ext.	int.														
BTS-PUR	PUR	PUR	Polyester	0.35	Black	x	x	x		+	+	++	+	o	-	+
ERA 7810	PUR	PUR	Polyester	0.22	Blk/Gry	x	x			+	o	o	o	o	-	++
PUR-Kevlar	PUR	PUR	Kevlar	0.36	Blk/Gry	x	x	x	x	++	+	++	+	+	+	+
BTS-23	PVC	PVC	Polyester	0.23	Black	x	x			+	-	o	-	-	-	++
BTS-35	PVC	PVC	Polyester	0.36	Black	x	x	x		+	+	+	o	o	-	+
Alum-Aramid	ALU		Nomex	0.35	Silver	x	x		x	+	o	+	++	++	+	+
PUR/Teflon	PTFE	PUR	Polyester	0.30	Black	x	x	x		++	++	++	o	o	-	+
Neoprene	NEP	NEP	Nylon	0.40	Black	x	x	x	x	++	++	++	++	o	-	o
Hypalon	HYP	HYP	Nylon	0.40	Black	x	x	x	x	+	++	+	o	o	-	o

- unsuitable, o suitable, + good, ++ very good

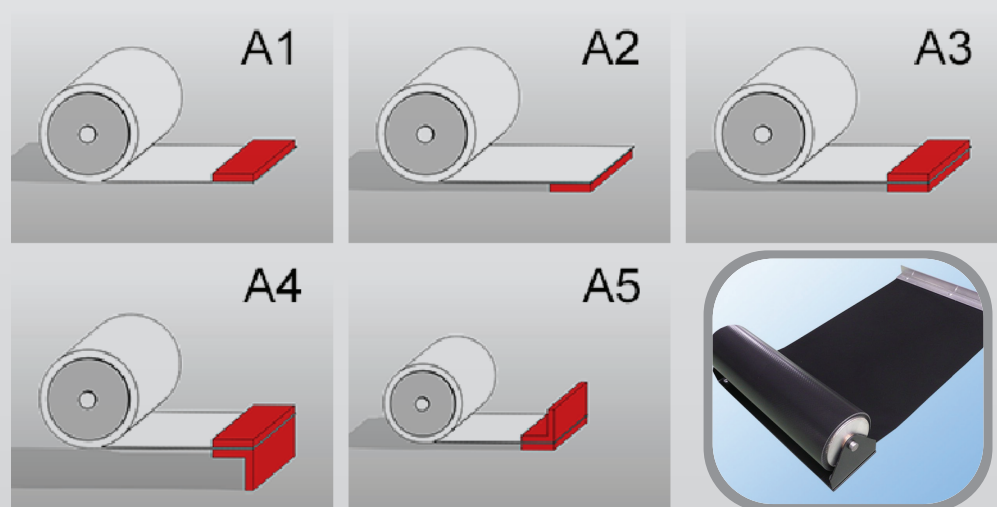
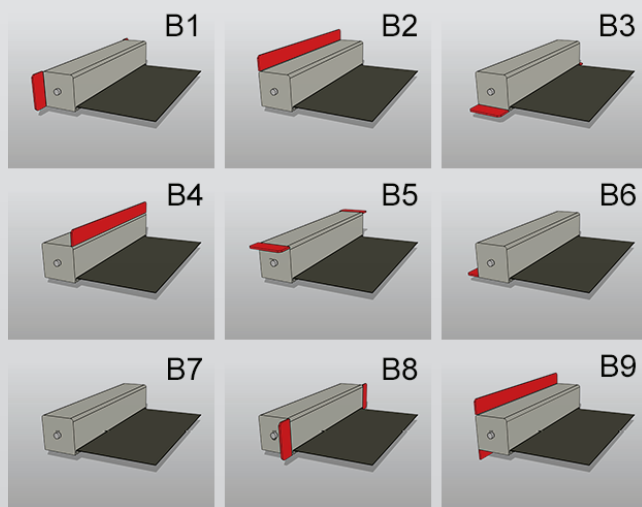
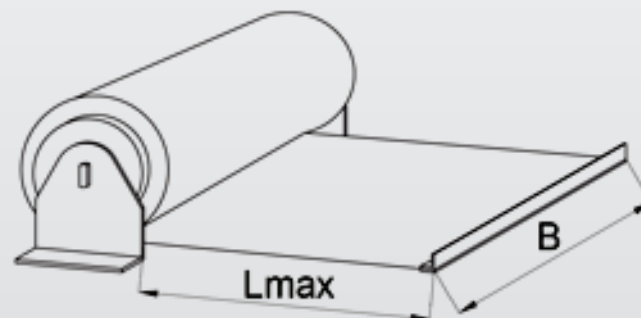
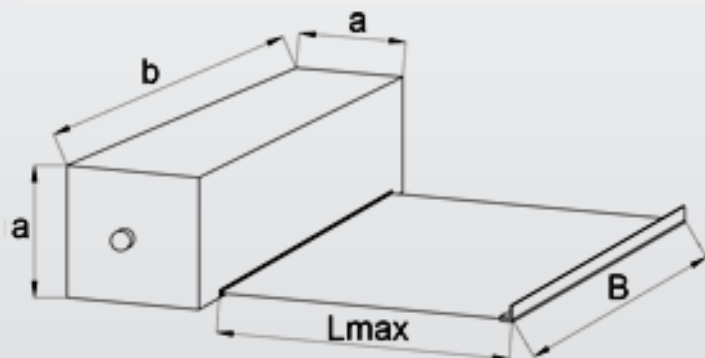

Alüminyum Perde

Aluminum Covers

Çelik alaşımlı alüminyum ve poliüretan fitillerin montajlanmasıyla üretilen BTS Cover Alüminyum Koruma Sistemleri metal talaşın ve soğutma sıvısının oluşturabileceği zararları engeller, iş güvenliği için tehdit oluşturan bölgelerde kalıcı çözümler sunar. Uygun maliyeti olmasına karşı yüksek koruma değeri sağlayan BTS Cover Alüminyum Koruma Sistemleri, düşük fiyat ve yüksek çalışma süresi garanti eder.

Alüminyum Perde

Aluminum Covers



BTS-A



BTS-B

KG / M²Maksimum Genişlik
Max. WidthEğilme Dayanımı
Bending Strength

9,1

6000mm.

6000mm.

12,2

6000mm.

6000mm.

Platform K r kleri

Platform Bellows

BTS Cover Platform K r kleri, mekanik korumanın yanı sıra iŐ g venliĐi konusunda maksimum koruma saĐlar. alıŐma sırasında operat r n el ve ayak sıklıŐmasını engellediĐi gibi makina ierisindeki hareketli sistemlerin dıŐ etkenlere baĐlı alıŐma bozukluklarını ortadan kaldırır.

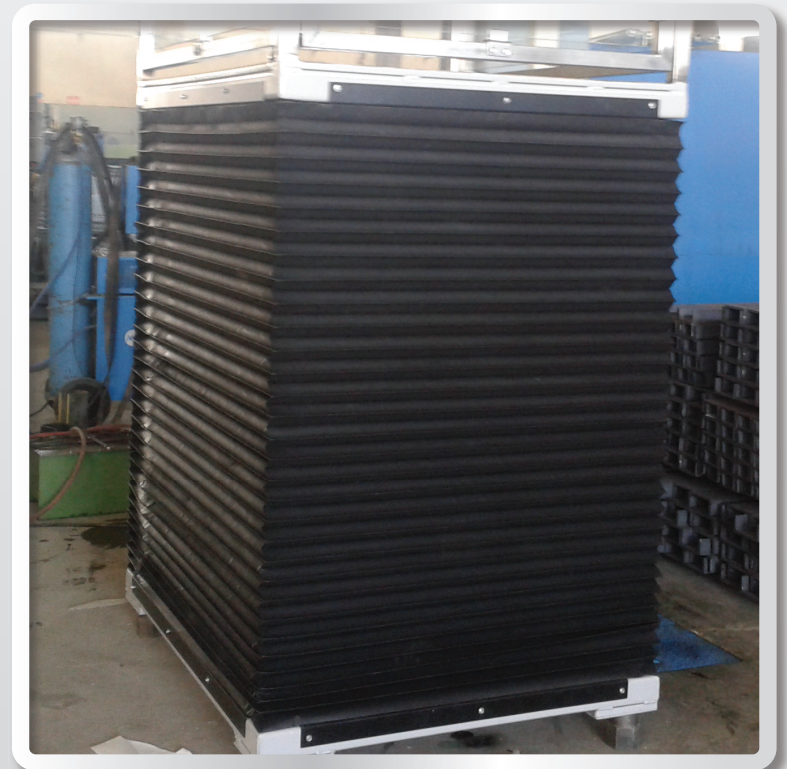
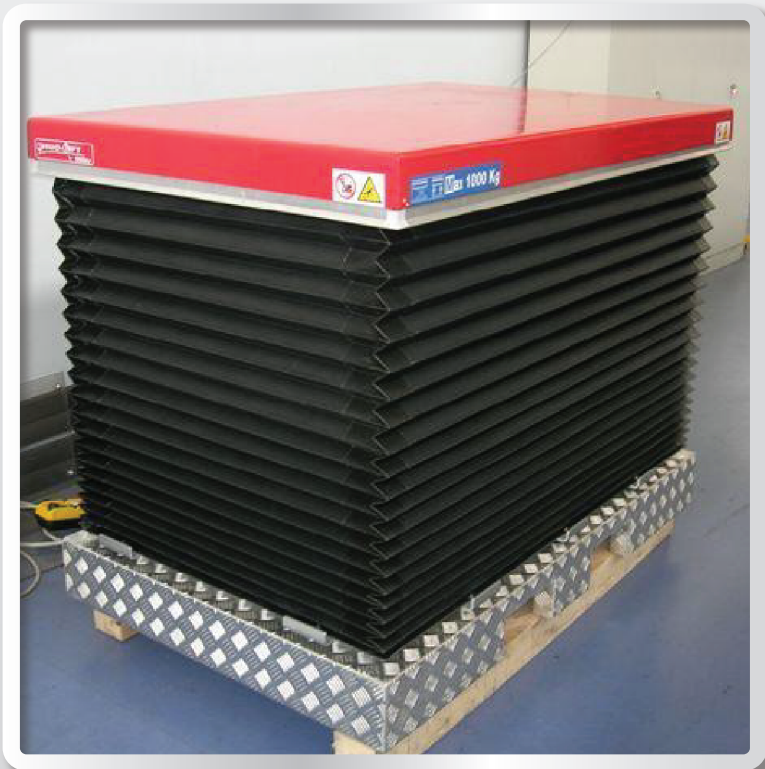



Platform K r kleri



Platform Bellows

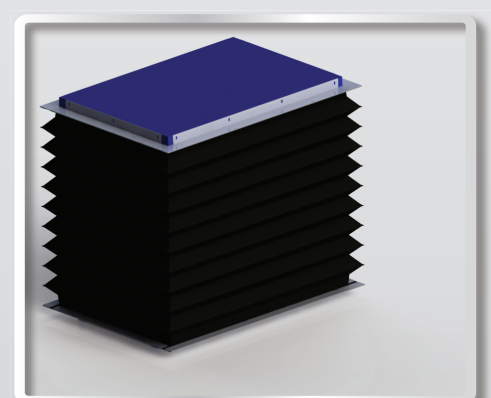
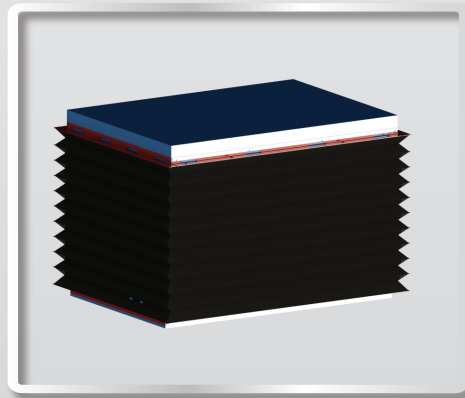
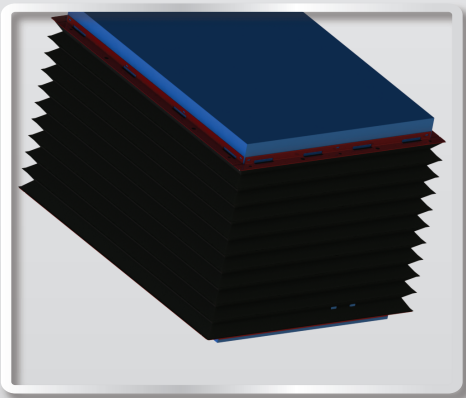
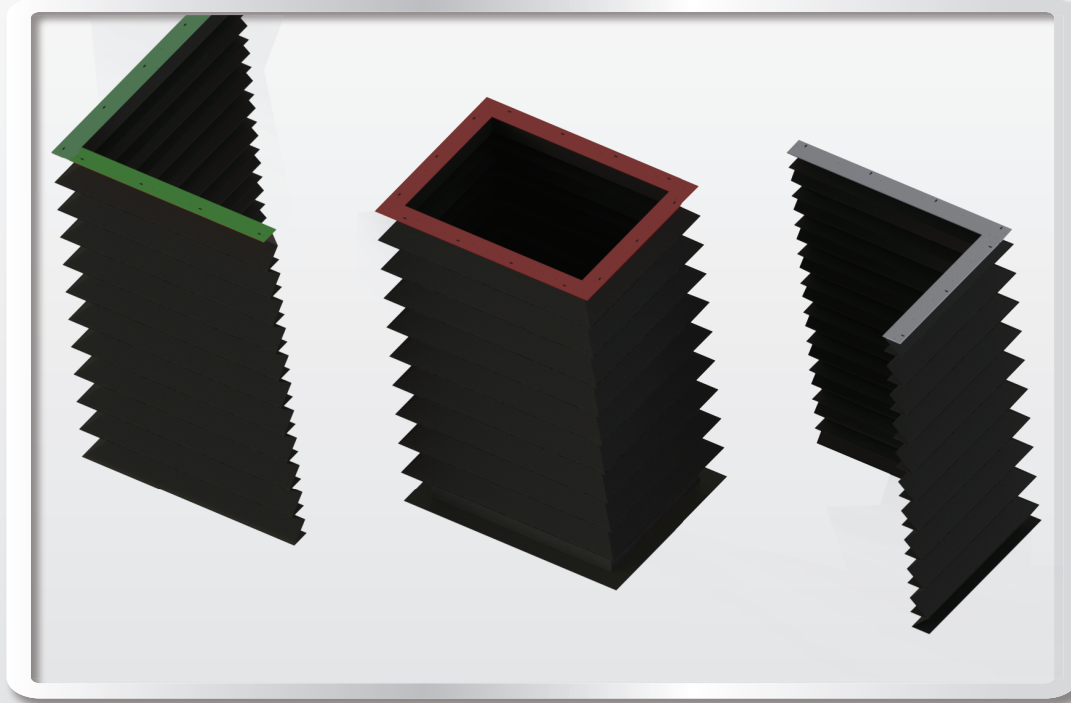

Sprial Yay Muhafazalar

Spiral Spring Cover

Paslanmaz çelikten birden fazla yayın art arda birleştirilmesiyle üretilen Spring Cover genellikle vidalı mil korumalarında kullanılmaktadır.

Yatay ve dikey konumda kullanılan Spring Cover için geliştirilen özel yağlar ile aşınma minimum seviyede tutulur.



Abbreviations

SD Maximum external diameter of the covered part

ID Internal diameter of the spiral spring

IF Internal diameter of the centring flange (ID - 2 mm)

AD External diameter of the spiral spring (± 2 mm)

AF Internal diameter of the large centring flange (AD + 4 mm)

Lh Maximum extension with horizontal use

Lv Maximum extension with vertical use

BB Used strip width (corresponds to Lmin)

n Not supplied

All dimensions are stated in mm

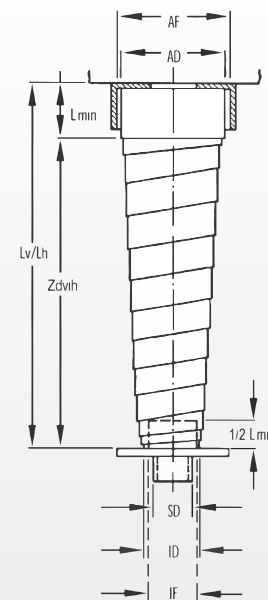

Type	SD	ID	AD	Lh	Lv	BB	Type	SD	ID	AD	Lh	Lv	BB	Type	SD	ID	AD	Lh	Lv	BB
15-70-20	11	15	22	na	70	20	25-450-40	21	25	48	370	450	40	30-650-50	26	30	55	590	650	50
15-100-20	11	15	22	60	100	20	25-500-40	21	25	51	420	500	40	30-750-50	26	30	59	690	750	50
15-120-20	11	15	22	90	120	20	25-450-50	21	25	40	390	450	50	30-650-60	26	30	52	590	650	60
15-150-20	11	15	25	110	150	20	25-500-50	21	25	42	440	500	50	30-750-60	26	30	57	690	750	60
15-200-20	11	15	28	160	200	20	25-550-50	21	25	43	490	550	50	30-900-60	26	30	59	840	900	60
15-300-20	11	15	30	260	300	20	25-600-50	21	25	44	540	600	50	30-1000-60	26	30	62	940	1000	60
20-100-20	16	20	31	60	100	20	25-650-50	21	25	45	590	650	50	35-100-20	31	35	46	60	100	20
20-150-20	16	20	34	110	150	20	25-750-50	21	25	47	690	750	50	35-100-30	31	35	44	60	100	30
20-200-20	16	20	36	160	200	20	25-900-50	21	25	57	840	900	50	35-150-30	31	35	48	90	150	30
20-250-20	16	20	40	210	250	20	30-150-30	26	30	39	90	150	30	35-200-30	31	35	50	140	200	30
20-300-20	16	20	41	260	300	20	30-200-30	26	30	42	140	200	30	35-250-30	31	35	52	190	250	30
20-250-30	16	20	36	210	250	30	30-250-30	26	30	44	190	250	30	35-300-30	31	35	55	240	300	30
20-300-30	16	20	39	260	300	30	30-300-30	26	30	46	240	300	30	35-350-30	31	35	61	290	350	30
20-350-30	16	20	42	310	350	30	30-350-30	26	30	49	290	350	30	35-400-30	31	35	63	340	400	30
20-400-30	16	20	45	360	400	30	30-400-30	26	30	52	340	400	30	35-300-40	31	35	48	240	300	40
20-400-40	16	20	38	360	400	40	30-450-30	26	30	53	390	450	30	35-350-40	31	35	50	290	350	40
20-450-40	16	20	41	410	450	40	30-450-40	26	30	53	370	450	40	35-400-40	31	35	54	340	400	40
20-500-40	16	20	48	460	500	40	30-500-40	26	30	56	440	500	40	35-450-40	31	35	58	390	450	40
25-100-20	21	25	35	60	100	20	30-550-40	26	30	58	490	550	40	35-500-40	31	35	60	440	500	40
25-150-20	21	25	38	110	150	20	30-600-40	26	30	60	540	600	40	35-550-40	31	35	62	490	550	40
25-200-20	21	25	41	160	200	20	30-650-40	26	30	62	590	650	40	35-350-50	31	35	52	290	350	50
25-250-20	21	25	44	210	250	20	30-700-40	26	30	64	640	700	40	35-400-50	31	35	54	340	400	50
25-300-20	21	25	47	260	300	20	30-150-50	26	30	40	90	150	50	35-450-50	31	35	54	390	450	50
25-300-30	21	25	43	240	300	30	30-250-50	26	30	43	190	250	50	35-500-50	31	35	56	440	500	50
25-350-30	21	25	46	290	350	30	30-350-50	26	30	46	290	350	50	35-550-50	31	35	58	490	550	50
25-400-30	21	25	49	340	400	30	30-450-50	26	30	48	390	450	50	35-650-50	31	35	61	590	650	50
25-450-30	21	25	48	390	450	30	30-550-50	26	30	50	490	550	50	35-750-50	31	35	65	690	750	50

Type	SD	ID	AD	Lh	Lv	BB
35-850-50	31	35	65	790	850	50
35-450-60	31	35	53	390	450	60
35-550-60	31	35	56	490	550	60
35-650-60	31	35	59	590	650	60
35-750-60	31	35	64	690	750	60
35-850-60	31	35	64	790	850	60
35-550-75	31	35	55	490	550	75
35-650-75	31	35	57	590	650	75
35-750-75	31	35	58	690	750	75
35-850-75	31	35	59	790	850	75
40-150-30	36	40	51	90	150	30
40-250-30	36	40	56	190	250	30
40-350-30	36	40	60	290	350	30
40-450-30	36	40	65	390	450	30
40-350-40	36	40	62	290	350	40
40-400-40	36	40	63	340	400	40
40-450-40	36	40	65	390	450	40
40-500-40	36	40	66	440	500	40
40-550-40	36	40	68	490	550	40
40-350-50	36	40	55	250	350	50
40-450-50	36	40	59	350	450	50
40-550-50	36	40	61	450	550	50
40-650-50	36	40	66	550	650	50
40-750-50	36	40	69	650	750	50
40-850-50	36	40	71	750	850	50
40-350-60	36	40	55	230	350	60
40-450-60	36	40	55	330	450	60
40-550-60	36	40	58	430	550	60
40-650-60	36	40	62	530	650	60
40-750-60	36	40	66	630	750	60
40-900-60	36	40	70	780	900	60
40-650-75	36	40	63	500	650	75
40-750-75	36	40	66	600	750	75
40-900-75	36	40	72	750	900	75
40-1100-75	36	40	78	950	1100	75
40-1300-75	36	40	84	1150	1300	75
40-1500-75	36	40	87	na	1500	75
40-1000-100	36	40	69	800	1000	100
40-1200-100	36	40	71	1000	1200	100
40-1300-100	36	40	75	1100	1300	100
40-1400-100	36	40	76	1200	1400	100
40-1500-100	36	40	79	1300	1500	100
40-1600-100	36	40	81	1400	1600	100
40-1800-100	36	40	82	1600	1800	100
40-1800-120	36	40	83	1560	1800	120
40-2000-120	36	40	86	1760	2000	120
40-2200-120	36	40	91	na	2200	120

Type	SD	ID	AD	Lh	Lv	BB
45-700-60	41	45	70	630	700	60
45-650-75	41	45	68	500	650	75
45-750-75	41	45	76	600	750	75
45-900-75	41	45	78	750	900	75
45-1100-75	41	45	84	950	1100	75
45-1200-75	41	45	86	1150	1200	75
45-1300-75	41	45	89	na	1300	75
45-1000-100	41	45	71	800	1000	100
45-1200-100	41	45	75	1000	1200	100
45-1300-100	41	45	79	1100	1300	100
45-1400-100	41	45	81	1200	1400	100
45-1500-100	41	45	84	1300	1500	100
45-1600-100	41	45	87	1400	1600	100
45-1800-100	41	45	87	na	1800	100
45-1800-120	41	45	90	1560	1800	120
45-2000-120	41	45	91	1760	2000	120
45-2200-120	41	45	100	na	2200	120
50-150-30	46	50	63	90	150	30
50-250-30	46	50	68	190	250	30
50-350-30	46	50	68	290	350	30
50-250-50	46	50	62	150	250	50
50-350-50	46	50	66	250	350	50
50-450-50	46	50	70	350	450	50
50-550-50	46	50	73	450	550	50
50-650-50	46	50	76	550	650	50
50-350-60	46	50	67	230	350	60
50-450-60	46	50	66	330	450	60
50-550-60	46	50	68	430	550	60
50-650-60	46	50	73	530	650	60
50-750-60	46	50	76	630	750	60
50-900-60	46	50	82	780	900	60
50-750-75	46	50	78	600	750	75
50-900-75	46	50	84	750	900	75
50-1100-75	46	50	90	950	1100	75
50-1200-75	46	50	94	1050	1200	75
50-1100-100	46	50	77	900	1100	100
50-1300-100	46	50	80	1100	1300	100
50-1500-100	46	50	87	1300	1500	100
50-1600-100	46	50	92	1400	1600	100
50-1700-100	46	50	93	na	1700	100
50-1800-100	46	50	94	na	1800	100
50-1700-120	46	50	91	1460	1700	120
50-1900-120	46	50	97	1660	1900	120
50-2100-120	46	50	102	1860	2100	120
50-2300-120	46	50	105	na	2300	120
50-2500-120	46	50	111	na	2500	120
50-2800-120	46	50	119	na	2800	120

Type	SD	ID	AD	Lh	Lv	BB
55-650-50	51	55	80	450	650	50
55-550-60	51	55	75	430	550	60
55-650-60	51	55	79	530	650	60
55-750-60	51	55	83	630	750	60
55-800-60	51	55	86	680	800	60
55-900-60	51	55	89	780	900	60
55-1000-60	51	55	92	na	1000	60
55-600-75	51	55	86	450	600	75
55-750-75	51	55	83	600	750	75
55-900-75	51	55	89	750	900	75
55-1100-75	51	55	94	950	1100	75
55-1100-100	51	55	88	900	1100	100
55-1300-100	51	55	89	1100	1300	100
55-1500-100	51	55	94	1300	1500	100
55-1800-100	51	55	102	na	1800	100
55-1300-120	51	55	86	1060	1300	120
55-1500-120	51	55	94	1260	1500	120
55-1700-120	51	55	96	1460	1700	120
55-1900-120	51	55	103	1660	1900	120
55-2100-120	51	55	106	1860	2100	120
55-2300-120	51	55	110	2060	2300	120
55-2500-120	51	55	117	na	2500	120
55-2800-120	51	55	119	na	2800	120
55-2500-150	51	55	121	2200	2500	150
55-2800-150	51	55	122	2500	2800	150
55-3000-150	51	55	126	na	3000	150
55-3500-150	51	55	130	na	3500	150
55-2800-180	51	55	116	2500	2800	180
55-3000-180	51	55	127	2640	3000	180
55-3250-180	51	55	130	na	3250	180
55-3500-180	51	55	132	na	3500	180
60-150-30	56	60	73	90	150	30
60-250-30	56	60	78	190	250	30
60-250-50	56	60	72	150	250	50
60-350-50	56	60	78	250	350	50
60-450-50	56	60	82	350	450	50
60-550-50	56	60	86	450	550	50
60-450-60	56	60	78	430	450	60
60-550-60	56	60	81	430	550	60
60-650-60	56	60	85	530	650	60
60-750-60	56	60	89	630	750	60
60-800-60	56	60	96	680	800	60
60-900-60	56	60	97	na	900	60
60-750-75	56	60	89	600	750	75
60-900-75	56	60	95	750	900	75
60-1100-75	56	60	102	950	1100	75
60-1300-75	56	60	104	1150	1300	75

Type	SD	ID	AD	Lh	Lv	BB
45-150-30	41	45	56	90	150	30
45-250-30	41	45	62	190	250	30
45-350-30	41	45	65	290	350	30
45-400-30	41	45	66	340	400	30
45-350-40	41	45	67	290	350	40
45-400-40	41	45	68	340	400	40
45-450-40	41	45	69	390	450	40
45-500-40	41	45	71	na	500	40
45-450-50	41	45	67	350	450	50
45-550-50	41	45	68	450	550	50
45-650-50	41	45	72	550	650	50
45-350-60	41	45	63	230	350	60
45-450-60	41	45	64	330	450	60
45-550-60	41	45	65	430	550	60
45-650-60	41	45	70	530	650	60
60-3000-180	56	60	128	2640	3000	180
60-3250-180	56	60	132	na	3250	180
60-3250-200	56	60	132	2850	3250	200
60-3500-200	56	60	139	na	3500	200
65-100-30	61	65	76	90	100	30
65-150-30	61	65	78	90	150	30
65-250-30	61	65	85	190	250	30
65-250-50	61	65	76	150	250	50
65-350-50	61	65	83	250	350	50
65-450-50	61	65	88	350	450	50
65-550-50	61	65	92	450	550	50
65-500-60	61	65	86	380	500	60
65-550-60	61	65	88	430	550	60
65-650-60	61	65	92	530	650	60
65-700-60	61	65	94	580	700	60
65-750-60	61	65	96	630	750	60
65-800-60	61	65	98	680	800	60
65-850-60	61	65	100	730	850	60
65-900-60	61	65	104	780	900	60
65-750-75	61	65	93	600	750	75
65-800-75	61	65	96	650	800	75
65-900-75	61	65	99	750	900	75
65-1100-75	61	65	107	900	1100	75
65-1300-75	61	65	111	1100	1300	75
65-1500-75	61	65	115	na	1500	75
65-1000-100	61	65	91	800	1000	100
65-1100-100	61	65	95	900	1100	100
65-1300-100	61	65	100	1100	1300	100
65-1500-100	61	65	109	1300	1500	100
65-1700-100	61	65	114	na	1700	100
65-1800-100	61	65	120	na	1800	100
65-1500-120	61	65	102	1260	1500	120

Type	SD	ID	AD	Lh	Lv	BB
50-2500-150	46	50	117	2200	2500	150
50-2800-150	46	50	119	2500	2800	150
50-3000-150	46	50	124	na	3000	150
50-3000-180	46	50	123	2640	3000	180
50-3250-180	46	50	130	na	3250	180
50-3250-200	46	50	128	2850	3250	200
50-3500-200	46	50	134	na	3500	200
55-150-30	51	55	68	90	150	30
55-250-30	51	55	73	190	250	30
55-300-40	51	55	71	220	300	40
55-450-40	51	55	76	370	450	40
55-250-50	51	55	66	150	250	50
55-350-50	51	55	71	250	350	50
55-450-50	51	55	74	350	450	50
55-550-50	51	55	77	450	550	50
70-900-75	66	70	106	750	900	75
70-1100-75	66	70	113	900	1100	75
70-700-100	66	70	90	700	700	100
70-900-100	66	70	98	900	900	100
70-1100-100	66	70	102	900	1100	100
70-1300-100	66	70	107	1100	1300	100
70-1500-100	66	70	115	1300	1500	100
70-1800-100	66	70	124	na	1800	100
70-1500-120	66	70	112	1260	1500	120
70-1800-120	66	70	118	1560	1800	120
70-2000-120	66	70	125	1760	2000	120
70-2200-120	66	70	130	1960	2200	120
70-2400-120	66	70	138	na	2400	120
70-2600-120	66	70	143	na	2600	120
70-2800-120	66	70	147	na	2800	120
70-3000-120	66	70	147	na	3000	120
70-2000-150	66	70	129	1700	2000	150
70-2400-150	66	70	135	2100	2400	150
70-2800-150	66	70	139	na	2800	150
70-3000-150	66	70	149	na	3000	150
70-2800-180	66	70	138	2440	2800	180
70-3000-180	66	70	141	na	3000	180
70-3250-180	66	70	153	na	3250	180
70-3250-200	66	70	144	2850	3250	200
70-3500-200	66	70	155	na	3500	200
75-150-30	71	75	92	90	150	30
75-250-30	71	75	99	190	250	30
75-250-50	71	75	89	150	250	50
75-350-50	71	75	94	250	350	50
75-450-50	71	75	101	350	450	50
75-500-50	71	75	105	400	500	50
75-550-60	71	75	100	430	550	60

Type	SD	ID	AD	Lh	Lv	BB
60-900-100	56	60	85	700	900	100
60-1100-100	56	60	90	900	1100	100
60-1300-100	56	60	94	1100	1300	100
60-1500-100	56	60	101	1300	1500	100
60-1800-100	56	60	109	na	1800	100
60-1700-120	56	60	101	1460	1700	120
60-1900-120	56	60	104	1660	1900	120
60-2100-120	56	60	112	1860	2100	120
60-2300-120	56	60	114	2060	2300	120
60-2500-120	56	60	119	na	2500	120
60-2800-120	56	60	127	na	2800	120
60-2500-150	56	60	118	2300	2500	150
60-2800-150	56	60	123	2500	2800	150
60-3000-150	56	60	129	na	3000	150
60-3500-150	56	60	140	na	3500	150
75-3250-180	71	75	156	na	3250	180
75-3250-200	71	75	148	2850	3250	200
75-3500-200	71	75	158	na	3500	200
80-150-30	76	80	98	90	150	30
80-250-30	76	80	105	190	250	30
80-250-50	76	80	96	150	250	50
80-350-50	76	80	104	250	350	50
80-450-50	76	80	111	350	450	50
80-550-50	76	80	114	450	550	50
80-450-60	76	80	102	330	450	60
80-550-60	76	80	106	430	550	60
80-650-60	76	80	110	530	650	60
80-750-60	76	80	115	630	750	60
80-550-75	76	80	99	400	550	75
80-650-75	76	80	105	500	650	75
80-750-75	76	80	109	600	750	75
80-900-75	76	80	120	750	900	75
80-1000-75	76	80	123	850	1000	75
80-1200-75	76	80	128	na	1200	75
80-900-100	76	80	108	700	900	100
80-1100-100	76	80	114	900	1100	100
80-1300-100	76	80	120	1100	1300	100
80-1500-100	76	80	126	1300	1500	100
80-1800-100	76	80	134	na	1800	100
80-1300-120	76	80	116	1060	1300	120
80-1500-120	76	80	121	1260	1500	120
80-1800-120	76	80	129	1560	1800	120
80-2000-120	76	80	134	na	2000	120
80-2200-120	76	80	137	na	2200	120
80-2400-120	76	80	144	na	2400	120
80-2800-120	76	80	147	na	2800	120
80-2000-150	76	80	139	1700	2000	150

Type	SD	ID	AD	Lh	Lv	BB
65-1700-120	61	65	106	1460	1700	120
65-1900-120	61	65	109	1660	1900	120
65-2100-120	61	65	113	1860	2100	120
65-2300-120	61	65	118	2060	2300	120
65-2500-120	61	65	128	na	2500	120
65-2800-120	61	65	132	na	2800	120
65-3000-120	61	65	130	na	3000	120
65-2400-150	61	65	121	2100	2400	150
65-2800-150	61	65	133	2500	2800	150
65-3000-150	61	65	139	na	3000	150
65-3000-180	61	65	136	2640	3000	180
65-3250-180	61	65	146	na	3250	180
65-3250-200	61	65	140	2850	3250	200
65-3500-200	61	65	148	na	3500	200
70-150-30	66	70	85	90	150	30
70-250-30	66	70	93	190	250	30
70-350-30	66	70	99	290	350	30
70-250-50	66	70	84	150	250	50
70-350-50	66	70	89	250	350	50
70-450-50	66	70	94	350	450	50
70-550-50	66	70	98	450	550	50
70-650-50	66	70	100	na	650	50
70-550-60	66	70	94	430	550	60
70-650-60	66	70	97	530	650	60
70-750-60	66	70	103	630	750	60
70-900-60	66	70	113	800	900	60
70-500-75	66	70	94	350	500	75
70-600-75	66	70	94	450	600	75
70-700-75	66	70	98	550	700	75
70-800-75	66	70	100	650	800	75
85-1800-120	81	85	133	1560	1800	120
85-2000-120	81	85	138	na	2000	120
85-2000-150	81	85	144	1700	2000	150
85-2200-150	81	85	147	1900	2200	150
85-2400-150	81	85	152	2100	2400	150
85-2600-150	81	85	153	na	2600	150
85-2800-150	81	85	157	na	2800	150
85-3000-150	81	85	164	na	3000	150
85-2800-180	81	85	153	2440	2800	180
85-3000-180	81	85	159	na	3000	180
85-3250-180	81	85	166	na	3250	180
85-3000-200	81	85	159	2600	3000	200
85-3250-200	81	85	165	na	3250	200
85-3500-200	81	85	168	na	3500	200
90-150-30	86	90	110	90	150	30
90-250-50	86	90	116	190	250	30
90-150-50	86	90	112	50	150	50

Type	SD	ID	AD	Lh	Lv	BB
75-650-60	71	75	103	530	650	60
75-750-60	71	75	109	630	750	60
75-650-75	71	75	99	500	650	75
75-750-75	71	75	104	600	750	75
75-900-75	71	75	111	750	900	75
75-1000-75	71	75	120	850	1000	75
75-1100-75	71	75	125	950	1100	75
75-900-100	71	75	102	na	900	100
75-1100-100	71	75	108	900	1100	100
75-1200-100	71	75	112	1000	1200	100
75-1300-100	71	75	114	1100	1300	100
75-1500-100	71	75	120	1300	1500	100
75-1700-100	71	75	126	1500	1700	100
75-1800-100	71	75	128	1600	1800	100
75-2000-100	71	75	133	na	2000	100
75-2200-100	71	75	139	na	2200	100
75-1500-120	71	75	115	1260	1500	120
75-1800-120	71	75	125	1560	1800	120
75-2000-120	71	75	128	1760	2000	120
75-2200-120	71	75	132	na	2200	120
75-2400-120	71	75	141	na	2400	120
75-2600-120	71	75	143	na	2600	120
75-2800-120	71	75	149	na	2800	120
75-2000-150	71	75	135	1700	2000	150
75-2400-150	71	75	141	2100	2400	150
75-2600-150	71	75	144	na	2600	150
75-2800-150	71	75	145	na	2800	150
75-3000-150	71	75	153	na	3000	150
75-2800-180	71	75	143	2440	2800	180
75-3000-180	71	75	148	na	3000	180
100-1100-120	96	100	130	860	1100	120
100-1300-120	96	100	135	1060	1300	120
100-1500-120	96	100	144	na	1500	120
100-1800-120	96	100	148	na	1800	120
100-1500-150	96	100	147	1200	1500	150
100-1800-150	96	100	153	1500	1800	150
100-2000-150	96	100	157	1700	2000	150
100-2500-150	96	100	164	na	2500	150
100-2800-150	96	100	172	na	2800	150
100-3000-150	96	100	186	na	3000	150
100-2500-180	96	100	162	2140	2500	180
100-2800-180	96	100	168	na	2800	180
100-3000-180	96	100	174	na	3000	180
100-2800-200	96	100	169	na	2800	200
100-3000-200	96	100	188	na	3000	200
110-250-50	106	110	130	na	250	50
110-250-60	106	110	131	130	250	60

Type	SD	ID	AD	Lh	Lv	BB
80-2200-150	76	80	142	1900	2200	150
80-2400-150	76	80	152	2100	2400	150
80-2600-150	76	80	148	2300	2600	150
80-2800-150	76	80	152	na	2800	150
80-3000-150	76	80	159	na	3000	150
80-2800-180	76	80	127	2440	2800	180
80-3000-180	76	80	154	na	3000	180
80-3250-180	76	80	161	na	3250	180
80-3000-200	76	80	154	2600	3000	200
80-3250-200	76	80	160	na	3250	200
80-3500-200	76	80	163	na	3500	200
85-150-30	81	85	103	90	150	30
85-250-30	81	85	110	190	250	30
85-250-50	81	85	104	150	250	50
85-350-50	81	85	110	250	350	50
85-450-50	81	85	116	350	450	50
85-550-50	81	85	119	450	550	50
85-450-60	81	85	107	330	450	60
85-550-60	81	85	111	430	550	60
85-650-60	81	85	115	530	650	60
85-550-75	81	85	108	400	550	75
85-650-75	81	85	109	500	650	75
85-750-75	81	85	114	600	750	75
85-900-75	81	85	125	750	900	75
85-900-100	81	85	113	700	900	100
85-1100-100	81	85	119	900	1100	100
85-1300-100	81	85	125	1100	1300	100
85-1500-100	81	85	127	1300	1500	100
85-1300-120	81	85	120	1060	1300	120
85-1500-120	81	85	126	1260	1500	120
120-2200-200	116	120	166	1800	2200	200
120-2400-200	116	120	170	na	2400	200
120-2600-200	116	120	174	na	2600	200
130-155-50	126	130	145	na	155	50
130-170-50	126	130	150	na	170	50
130-250-60	126	130	152	na	250	60
130-350-60	126	130	156	na	350	60
130-450-60	126	130	158	na	450	60
130-250-75	126	130	146	na	250	75
130-350-75	126	130	150	na	350	75
130-450-75	126	130	156	na	450	75
130-650-100	126	130	157	na	650	100
130-800-100	126	130	164	na	800	100
130-600-120	126	130	158	360	600	120
130-800-120	126	130	162	560	800	120
130-1000-120	126	130	164	760	1000	120
130-1100-120	126	130	166	na	1100	120

Type	SD	ID	AD	Lh	Lv	BB	Type	SD	ID	AD	Lh	Lv	BB	Type	SD	ID	AD	Lh	Lv	BB
90-250-50	86	90	116	150	250	50	110-350-60	106	110	135	230	350	60	130-900-150	126	130	163	500	900	150
90-350-50	86	90	121	250	350	50	110-450-60	106	110	139	330	450	60	130-1300-150	126	130	172	1000	1300	150
90-450-50	86	90	125	350	450	50	110-350-75	106	110	130	200	350	75	130-1500-150	126	130	176	1200	1500	150
90-350-60	86	90	112	230	350	60	110-450-75	106	110	135	300	450	75	130-1800-150	126	130	185	na	1800	150
90-450-60	86	90	114	330	450	60	110-600-75	106	110	141	450	600	75	130-1650-180	126	130	171	1650	1650	180
90-450-75	86	90	114	300	450	75	110-800-75	106	110	154	650	800	75	130-2000-200	126	130	180	2000	2000	200
90-550-75	86	90	119	400	550	75	110-650-100	106	110	131	450	650	100	140-250-60	136	140	162	190	250	60
90-650-75	86	90	124	500	650	75	110-750-100	106	110	134	560	750	100	140-250-75	136	140	159	150	250	75
90-750-75	86	90	128	600	750	75	110-900-100	106	110	139	700	900	100	140-350-75	136	140	161	250	350	75
90-900-75	86	90	133	750	900	75	110-1100-120	106	110	141	860	1100	120	140-450-75	136	140	165	350	450	75
90-750-100	86	90	116	550	750	100	110-1300-120	106	110	145	1060	1300	120	140-600-75	136	140	167	na	600	75
90-900-100	86	90	123	700	900	100	110-1500-120	106	110	155	1260	1500	120	140-350-100	136	140	154	250	350	100
90-1100-100	86	90	127	900	1100	100	110-1500-150	106	110	155	1200	1500	150	140-450-100	136	140	162	350	450	100
90-1300-100	86	90	132	1100	1300	100	110-1800-150	106	110	159	1500	1800	150	140-600-100	136	140	172	na	600	100
90-1500-100	86	90	144	1300	1500	100	110-2000-150	106	110	165	na	2000	150	140-700-120	136	140	173	460	700	120
90-1300-120	86	90	127	1060	1300	120	110-2000-180	106	110	159	1640	2000	180	140-1000-120	136	140	192	na	1000	120
90-1500-120	86	90	131	1260	1500	120	110-2200-180	106	110	165	1840	2200	180	140-1000-150	136	140	182	700	1000	150
90-1800-120	86	90	138	na	1800	120	110-2400-180	106	110	170	na	2400	180	140-1300-150	136	140	187	1000	1300	150
90-2000-120	86	90	150	na	2000	120	110-2400-200	106	110	163	2000	2400	200	140-1500-150	136	140	192	na	1500	150
90-1800-150	86	90	144	1500	1800	150	110-2600-200	106	110	166	na	2600	200	140-1900-200	136	140	185	1500	1900	200
90-2000-150	86	90	150	1700	2000	150	110-2800-200	106	110	172	na	2800	200	140-2000-200	136	140	193	na	2000	200
90-2300-150	86	90	154	na	2300	150	110-3000-200	106	110	176	na	3000	200	140-2400-200	136	140	204	na	2400	200
90-2600-150	86	90	159	na	2600	150	110-3500-200	106	110	189	na	3500	200	150-350-60	146	150	172	na	350	60
90-2800-150	86	90	162	na	2800	150	120-250-50	116	120	140	na	250	50	150-450-75	146	150	188	na	450	75
90-3000-150	86	90	166	na	3000	150	120-350-50	116	120	143	na	350	50	150-500-75	146	150	190	na	500	75
90-2600-180	86	90	152	2240	2600	180	120-250-60	116	120	141	130	250	60	150-600-75	146	150	194	na	600	75
90-2800-180	86	90	158	na	2800	180	120-350-60	116	120	145	230	350	60	150-750-150	146	150	180	na	750	100
90-3000-180	86	90	164	na	3000	180	120-450-60	116	120	150	330	450	60	150-850-150	146	150	182	na	850	100
90-2600-200	86	90	155	na	2600	200	120-450-75	116	120	141	200	350	75	150-1100-150	146	150	190	na	1100	100
90-3000-200	86	90	162	na	3000	200	120-450-75	116	120	145	300	450	75	150-1300-150	146	150	197	na	1300	100
90-3250-200	86	90	166	na	3250	200	120-600-75	116	120	152	450	600	75	160-250-60	156	160	178	na	250	60
90-3500-200	86	90	170	na	3500	200	120-650-100	116	120	141	450	650	100	160-250-75	156	160	179	na	250	75
90-3700-200	86	90	173	na	3700	200	120-750-100	116	120	145	550	750	100	160-450-75	156	160	183	na	450	75
90-4000-200	86	90	180	na	4000	200	120-900-100	116	120	150	700	900	100	160-450-100	156	160	182	na	450	100
90-4200-200	86	90	185	na	4200	200	120-900-120	116	120	148	660	900	120	160-650-120	156	160	192	na	650	120
90-4500-200	86	90	194	na	4500	200	120-1100-120	116	120	152	860	1100	120	160-750-120	156	160	193	na	750	120
100-250-60	96	100	121	130	250	60	120-1300-120	116	120	159	na	1300	120	160-800-150	156	160	198	na	800	150
100-350-60	96	100	126	230	350	60	120-1500-120	116	120	162	na	1500	120	160-950-150	156	160	201	na	950	150
100-350-75	96	100	119	200	350	75	120-1300-150	116	120	159	1000	1300	150	160-1000-150	156	160	202	na	1000	150
100-450-75	96	100	124	300	450	75	120-1500-150	116	120	163	1200	1500	150	160-1200-150	156	160	204	na	1200	150
100-600-75	96	100	129	450	600	75	120-1800-150	116	120	169	na	1800	150	160-1200-200	156	160	193	na	1200	200
100-800-75	96	100	138	650	800	75	120-2000-150	116	120	177	na	2000	150	160-1300-200	156	160	200	na	1300	150
100-800-100	96	100	126	600	800	100	120-1600-180	116	120	180	1240	1600	180	160-1400-200	156	160	212	na	1400	200
100-1000-100	96	100	134	800	1000	100	120-1800-180	116	120	180	1440	1800	180	160-2000-200	156	160	222	na	2000	200
100-1200-100	96	100	137	1000	1200	100	120-2000-180	116	120	180	1640	2000	180							
100-1500-100	96	100	140	1300	1500	100	120-2200-180	116	120	180	na	2200	180							

Teleskobik Koruma Materyalleri

Components Fot Telescopic Steel Cover

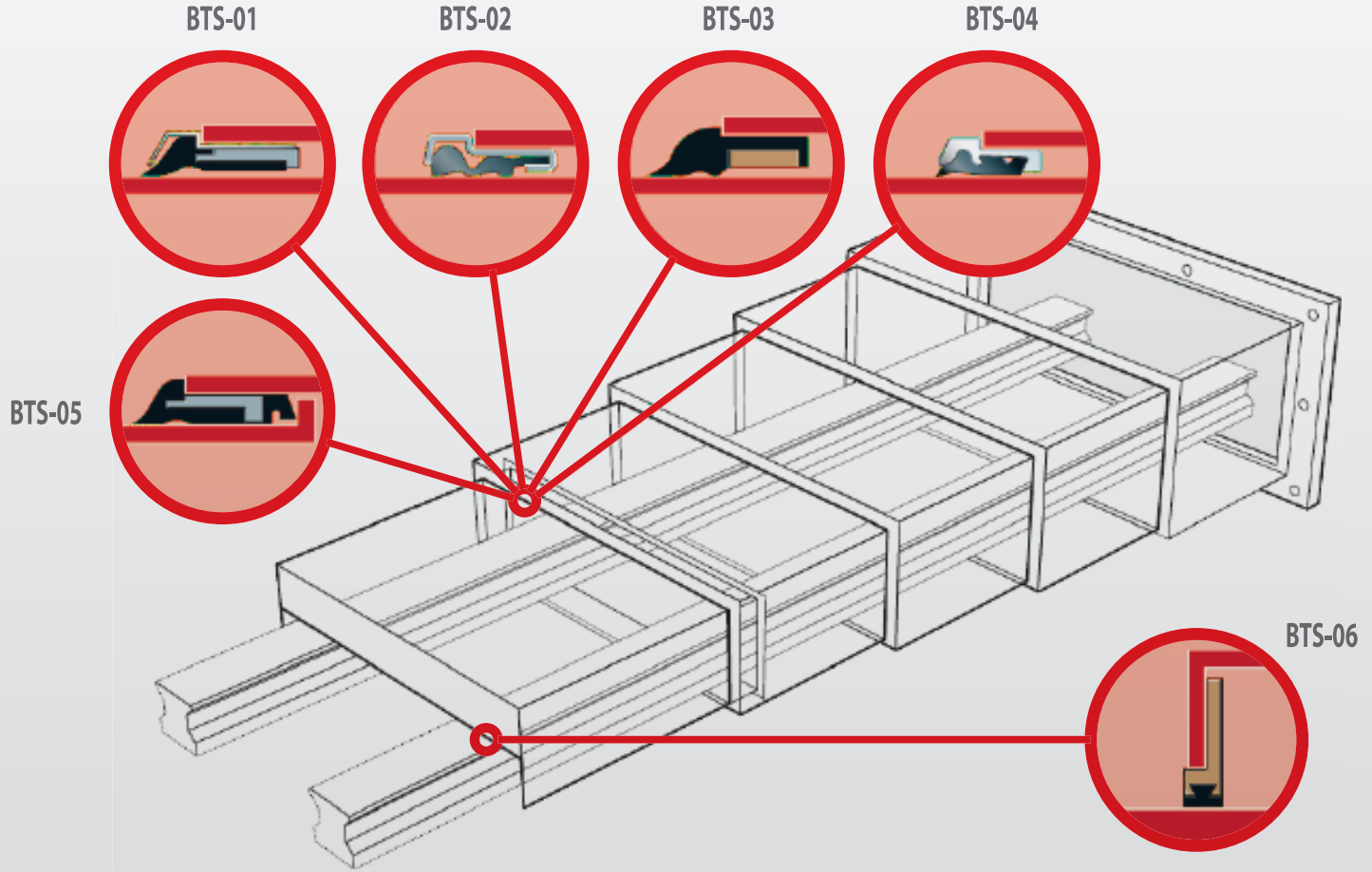

THK
The Mark of Linear Motion



SCHNEEBERGER
LINEAR TECHNOLOGY

HIWIN[®]
Motion Control and System Technology



COPERTINAX

WALLZEN

FASCIO

BRULENS

TRIPLON

BESONDEREX

TOURPOSTH

PLATEX

WIOSNA

BIEGENER



0.S.B. Işıktepe mh. 75. Yıl Bulv. No:5 Demirciler St. E /11 Nilüfer / BURSA



0.224 215 0 278



0.224 215 0 277



info@btscover.com